

PRESS BRAKES



Press Brakes
EuroMaster-S
PressMaster
SynchroMaster

HACO's Affordable Bending Solutions to the Highest Standards

Always the right choice for your application

- EuroMaster-S Series **4**
- PressMaster Series **10**
- SynchroMaster Series **28**

Equipment

- FastBEND-2D/3D MT Premium **16**
- New Standard Tooling System **18**
- Smart Tool Locator **19**
- Lasersafe Optical Safety Guards **20**
- Angle Measuring System Alfa-F **22**
- Sheet Following Systems **24**
- SyncView **26**

HACO's pressbrake series are the result of a decades long tradition in designing and manufacturing affordable **state-of-the art bending machines** for a wide variety of customers and applications.

HACO continues its policy of single source responsibility. Our in house developed **CNC controls** and **software solutions** have been recognized as being among the most user-friendly in the market. The new generation **Multi Touch** controls sets a new standard for an intuitive and user-friendly operator interface, introducing innovations such as **Smart Draft, Step Previewer** and **Combined Icons**.

HACO's attention for **design** and **manufacturing quality** has resulted in a worldwide reputation of long lasting production machines offering **excellent reliability** and **precision**.

Our Press Brakes Series



EuroMaster-S (EMS)

Standard Multifunctional Allround machine

General level pressbrake with market oriented execution. Extensive choice of options, both basic and sophisticated. Innovative 2D Multi Touch graphical control. Excellent price-performance ratio. Integration of advanced safety equipment.



PressMaster (PM)

Top Level High-Spec machine

Top level pressbrake with high-end specifications and execution. Increased Daylight Opening and Beam Stroke for increased bending freedom. Increased beam and backgauge speeds for high productivity. Innovative 3D Multi Touch graphical control. Possibility for extension with sophisticated options. Features accurate bending characteristics. Integration of advanced safety equipment.



SynchroMaster (SRM)

Entry Level Machine

Entry level pressbrake with basic execution for operation with European Standard Tooling. Possibility to extend with straightforward options. Attractive price/quality ratio. Standard with user friendly 2D graphical control.

FOLLOW THE HACO GROUP:
WWW.HACO.COM



TheHacoGroup



@haco_com



The HACO Group



hacogroup

EuroMaster-S Series

Your allround bending machine

EuroMaster-S Series



BEAM CONTROL

Beam parallelism and depth stop setting by means of bed referenced linear encoders for accurate beam position measurement, synchro module and proportional valve hydraulics

INTUITIVE FASTBEND-2D MT PREMIUM CONTROL

- Multi Touch Technology on 21.5" screen
- Intuitive Operator Interface
- Smart Draft
- Multi-Tasking
- Step Previewer
- Combined Icons
- Auto Tooling
- Pendant arm with optional height adjustment

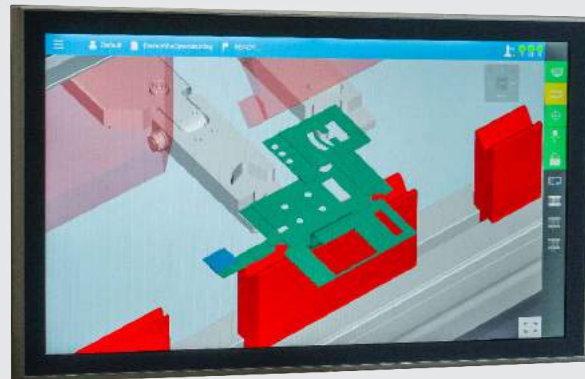

EUROPEAN STANDARD TOP TOOLING WITH QUICK MANUAL CLAMPING

Picture: New Standard Top and Bottom Tooling (optional)



CROWNING TABLE

Compensates for ram and table deflection, ensuring consistent bending angles over the entire bending length. Standard manual operation, optional CNC controlled (V-axis)

2-AXES X-R BACKGAUGE

Rigid and High Speed backgauge for accurate sheet positioning

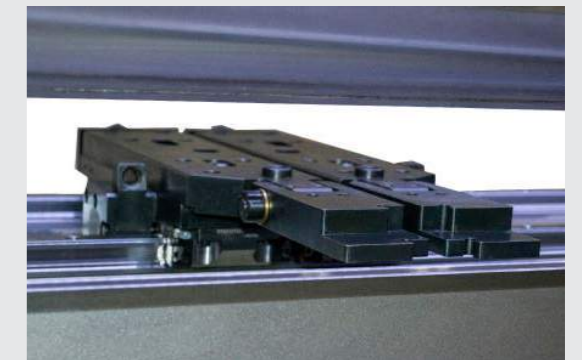

2 SHEET SUPPORTS WITH GUIDING



*Model 36150
Flush Floor frame
design for all models*

EuroMaster-S Series

Standard Execution

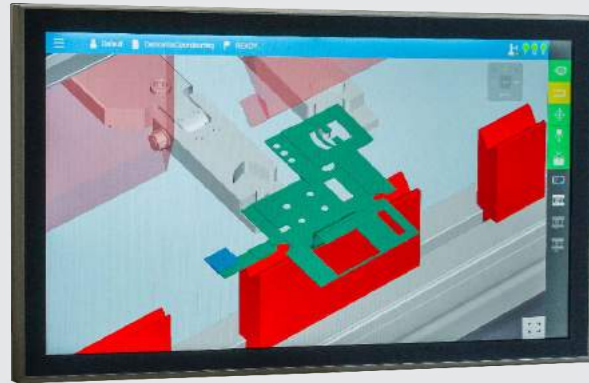

INTUITIVE FASTBEND-2D MT PREMIUM CONTROL

The application of Multi Touch technology reduces the number of keyboard- and button actions to an absolute minimum. The innovative Smart Draft, Design/Bending Multitasking, Step Previewer and Combined Icons features allow the operator a straightforward, intuitive control of the entire production cycle.



EUROPEAN STANDARD (ES) TOP TOOLING with Quick Manual Clamping arrangement and Manual Anti Deflection Table with clamping for ES dies

The European Standard Tooling System has proven its flexibility, affordability and precision during the last decades in an infinite number of sheet metal working shops. A wide choice of a vast number of top and bottom tools allows for an unpredictable number of applications in various materials and thicknesses.



HIGH SPEED X-R-BACKGAUGE

A rigid and accurate backgauge is an absolute condition for precision. High speed is an absolute condition for production output and short cycle times. The EuroMaster's X-R backgauge (and optional X-R-Z/Z' and X-R-Z1-Z2 versions) offers both. Manual finger width adjustment from the front.

EuroMaster-S Series

Standard Execution

- **FastBEND-2D MT Premium control**
 - Smart Draft + MultiTasking + Step Previewer + Combined Icons + Auto Tooling
 - 21.5" Multi Touch screen
- **High Speed X-R Backgauge for accurate sheet positioning**
 - Stroke X = 800mm, speed = 1000mm/s
 - Stroke R = 130mm, speed = 250mm/s
- **European Standard (ES) top clamping with Quick Manual Clamping Arrangement**
- **Intermediate clamping with height 100mm (up to 1500kN) or 150mm (from 2000kN)**
- **Manual Anti Deflection Table (Crowning) for ES dies, including nute for clamping single-V dies**
- **2 Sheet Supports 750 mm with guiding, manually adjustable in height**
- **LED illumination of the bending area**

Your Competitive Edge

A. Outstanding Price-Performance Ratio

B. State-Of-The-Art User Friendly 2D Multi Touch Control

C. Highest Part Precision

EuroMaster-S Series

Technical Specifications

Daylight Opening - Stroke - Gap

	Basic European Standard (ES)			Option ES High Specs			Option New Standard (NS)			Option NS High Specs		
	Daylight Opening	STROKE	GAP	Daylight Opening	STROKE	GAP	Daylight Opening	STROKE	GAP	Daylight Opening	STROKE	GAP
	D	E	C	D	E	C	D	E	C	D	E	C
750 kN	400	200	200	570	370	400	400	200	200	540	370	400
1000 kN	400	200	250	570	370	400	400	200	250	540	370	400
1500 kN	400	200	250	570	370	400	400	200	250	540	370	400
2000 kN	450	200	300	620	370	400	400	200	300	540	370	400
2500 kN	450	200	300	620	370	400	400	200	300	540	370	400
3200 kN	500	250	330	670	420	400	420	250	330	590	420	400
4000 kN	550	300	330	670	420	400	470	300	330	590	420	400

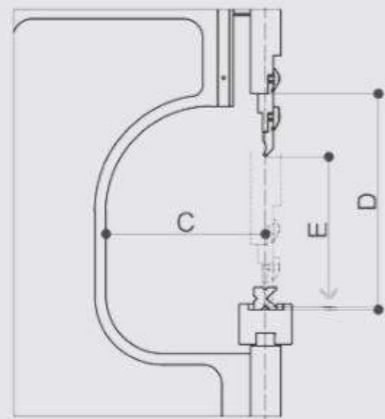

EUROPEAN STANDARD

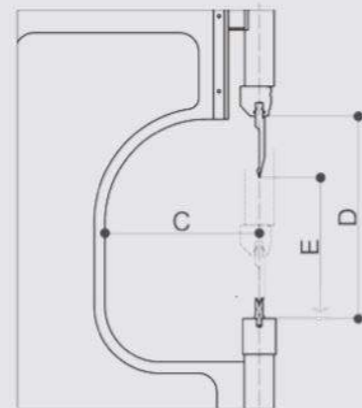

NEW STANDARD

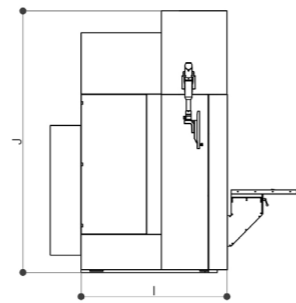
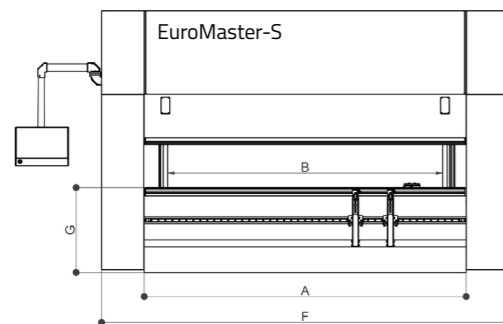

EuroMaster-S Series

Technical Specifications

(Valid for Basic European Standard)

	Bending length	Capacity	Distance between housings	Table Height	Fast Approach Speed	Max. Bending Speed	Fast Return Speed	Motor Power	Length	Width	Height	Weight
	A		B	G					F	I	J	
MODEL	mm	KN	mm	mm	mm/s	mm/s	mm/s	kW	mm	mm	mm	kg
20075	2100	750	1600	840	200	10	125	7.5	2450	1450	2500	4600
25075	2600	750	2100	840	200	10	125	7.5	2900	1450	2500	4900
30075	3100	750	2600	840	200	10	125	7.5	3500	1450	2500	5300
25100	2600	1000	2100	875	200	10	125	11	2900	1700	2500	6900
30100	3100	1000	2600	875	200	10	125	11	3500	1700	2500	7400
36100	3600	1000	3150	875	200	10	125	11	4100	1700	2500	8200
40100	4100	1000	3150	915	200	10	125	11	4400	1700	2500	9100
43100	4300	1000	3750	915	200	10	125	11	4700	1700	2850	10600
25150	2600	1500	2100	915	200	10	125	15	2900	1700	2500	7700
30150	3100	1500	2600	915	200	10	125	15	3500	1700	2500	8200
36150	3600	1500	3150	915	200	10	125	15	4100	1700	2500	9300
40150	4100	1500	3150	915	200	10	125	15	4400	1700	2500	10400
43150	4300	1500	3750	1010	200	10	125	15	4700	1700	2850	12900
25200	2600	2000	2100	965	200	8	125	18.7	2820	2000	2750	11200
30200	3100	2000	2600	965	200	8	125	18.7	3320	2000	2750	11600
36200	3600	2000	3150	965	200	8	125	18.7	3880	2000	2800	14500
40200	4100	2000	3150	965	200	8	125	18.7	4320	2000	2800	15400
43200	4300	2000	3750	965	200	8	125	18.7	4520	2000	2900	17200
30250	3100	2500	2600	965	100	8	90	18.7	3320	2000	2800	12900
36250	3600	2500	3150	965	100	8	90	18.7	3880	2050	2800	16000
40250	4100	2500	3150	890	100	8	90	18.7	4320	2050	2800	16900
43250	4300	2500	3750	890	100	8	90	18.7	4520	2050	3000	18700
50250	5000	2500	4050	940	100	8	90	18.7	5700	2050	3250	24300
60250	6000	2500	5050	1090	100	8	90	18.7	6700	2050	3700	31000
30320	3100	3200	2600	890	100	8	90	22.5	3320	2050	3000	17500
36320	3600	3200	3150	890	100	8	90	22.5	3880	2050	3100	20000
40320	4100	3200	3150	890	100	8	90	22.5	4320	2050	3200	21500
43320	4300	3200	3750	890	100	8	90	22.5	4520	2050	3200	23500
50320	5000	3200	4050	940	100	8	90	22.5	5700	2050	3300	28000
60320	6000	3200	5050	1090	100	8	90	22.5	6700	2050	3700	33000
30400	3100	4000	2600	1025	90	7	60	37.5	3550	2150	3860	26500
40400	4100	4000	3150	1045	90	7	60	37.5	4500	2150	3860	35000

Specifications subject to modifications without price notice

PressMaster Series

Your High Spec, High Performance bending machine

PressMaster Series



**INCREASED DAYLIGHT OPENING (540MM),
STROKE (370MM) AND GAP (400MM)**

BEAM CONTROL

Beam parallelism and depth stop setting by means of bed referenced linear encoders for accurate beam position measurement, synchro module and proportional valve hydraulics



SyncView

INTUITIVE FASTBEND-3D MT PREMIUM CONTROL

- Multi Touch Technology on 24" screen
- Intuitive Operator Interface
- Smart Draft
- Multi-Tasking
- Step Previewer
- Combined Icons
- Auto Tooling
- PartManager-3D

NEW STANDARD HYDRAULIC TOP TOOL CLAMPING

LAZERSAFE OPTICAL SAFETY GUARD (optional)



**CNC CROWNING TABLE WITH
HYDRAULIC CLAMPING FOR NEW
STANDARD BOTTOM TOOLING**

Compensates for ram and table deflection, ensuring consistent bending angles over the entire bending length.
CNC controlled (V-axis)

4-AXES X-R-Z1-Z2 BACKGAUGE

Rigid and High Speed backgauge for accurate sheet positioning



2 SHEET SUPPORTS WITH GUIDING



*Model 36150
Flush Floor frame
design for all models*

PressMaster Series

Standard Execution

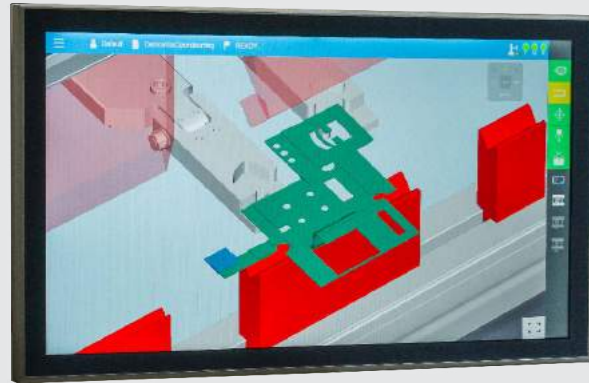

INTUITIVE FASTBEND-3D MT PREMIUM CONTROL

The application of Multi Touch technology reduces the number of keyboard- and button actions to an absolute minimum. The innovative Smart Draft, Design/Bending Multitasking, Step Previewer and Combined Icons features allow the operator a straightforward, intuitive control of the entire production cycle.

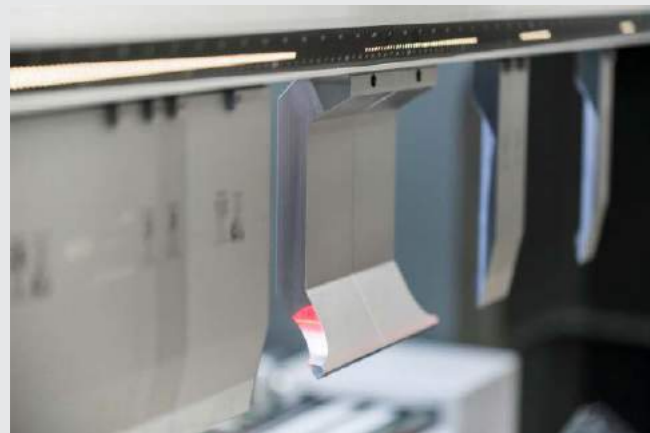

NEW STANDARD (NS)

hydraulic top tool clamping and CNC controlled Anti Deflection Table with hydraulic bottom tool clamping

The New Standard Tooling System has proven its flexibility and precision during the last decades in an infinite number of sheet metal working shops. A wide choice of a vast number of top and bottom tools allows for a unpredictable number of applications in various materials and thicknesses.

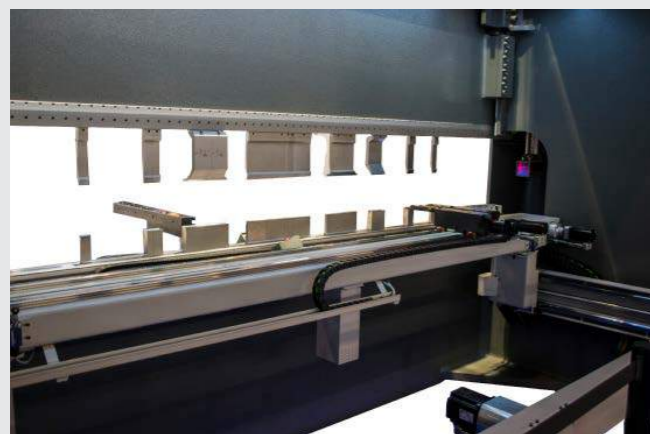

HIGH SPEED X-R-Z1-Z2 BACKGAUGE

A rigid and accurate backgauge is an absolute condition for precision. High speed is an absolute condition for production output and short cycle times. The PressMaster's X-R-Z1-Z2 backgauge offers both.

PressMaster Series

Standard Execution

- **FastBEND-3D MT Premium control**
 - Smart Draft + MultiTasking + Step Previewer + Combined Icons + Auto Tooling + Part Manager-3D
 - 24" Multi Touch screen
- **Increased Daylight Opening (540mm), Stroke (370mm) and Gap (400mm)**
- **Increased Fast Approach Beam Speed (up to 200mm/s) and**
- **Fast Return Speed (up to 170mm/s)**
- **High Speed X-R-Z1-Z2 Backgauge for accurate sheet positioning**
 - Stroke X = 800mm, speed = 1000mm/s
 - Stroke R = 130mm, speed = 250mm/s
 - Speed Z1 and Z2 axes = 1000mm/s
- **New Standard (NS) hydraulic top tool clamping**
- **CNC controlled Anti Deflection Table (Crowning) for NS dies**
- **2 Sheet Supports with guiding, manually adjustable in height**
- **LED illumination of the bending area**

Your Competitive Edge

A. Ultimate Price-Quality Ratio

B. State-Of-The-Art User Friendly 3D Multi Touch Control

C. Lowest Cycle Times

PressMaster Series

Technical Specifications

	Bending length	Capacity	Distance between housings	Gap	Daylight opening (NS)	Stroke	Table Height	Fast Approach Speed	Max. Bending Speed	Fast Return Speed	Motor Power	Length	Width	Height	Weight
	A		B	C	D	E	G					F	I	J	
MODEL	mm	kN	mm	mm	mm	mm	mm	mm/s	mm/s	mm/s	kW	mm	mm	mm	kg
20075	2100	750	1600	400	540	370	840	200	10	170	7.5	2450	1850	3250	5600
25075	2600	750	2100	400	540	370	840	200	10	170	7.5	2900	1850	3250	6000
30075	3100	750	2600	400	540	370	840	200	10	170	7.5	3500	1850	3250	6400
25100	2600	1000	2100	400	540	370	875	200	10	170	11	2900	2050	3250	8400
30100	3100	1000	2600	400	540	370	875	200	10	170	11	3500	2050	3250	9000
36100	3600	1000	3150	400	540	370	875	200	10	170	11	4100	2050	3250	9900
40100	4100	1000	3150	400	540	370	915	200	10	170	11	4400	2050	3250	11000
43100	4300	1000	3750	400	540	370	915	200	10	170	11	4700	2050	3600	12800
25150	2600	1500	2100	400	540	370	915	200	10	170	15	3300	2050	3250	9300
30150	3100	1500	2600	400	540	370	915	200	10	170	15	3500	2050	3250	9900
36150	3600	1500	3150	400	540	370	915	200	10	170	15	4100	2050	3250	11300
40150	4100	1500	3150	400	540	370	915	200	10	170	15	4400	2050	3250	12600
43150	4300	1500	3750	400	540	370	1010	200	10	170	15	4700	2050	3600	15600
25200	2600	2000	2100	400	540	370	965	200	8	170	18.7	2820	2300	3500	13600
30200	3100	2000	2600	400	540	370	965	200	8	170	18.7	3320	2300	3500	14100
36200	3600	2000	3150	400	540	370	965	200	8	170	18.7	3880	2300	3550	17600
40200	4100	2000	3150	400	540	370	965	200	8	170	18.7	4320	2300	3550	18600
43200	4300	2000	3750	400	540	370	965	200	8	170	18.7	4520	2300	3650	20800
30250	3100	2500	2600	400	540	370	965	100	8	90	18.7	3320	2350	3550	15600
36250	3600	2500	3150	400	540	370	965	100	8	90	18.7	3880	2350	3550	19400
40250	4100	2500	3150	400	540	370	890	100	8	90	18.7	4320	2350	3550	20500
43250	4300	2500	3750	400	540	370	890	100	8	90	18.7	4520	2350	3750	22600

Specifications subject to modifications without price notice

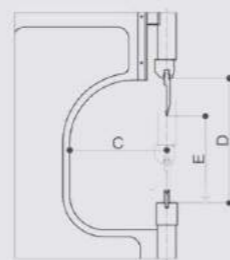
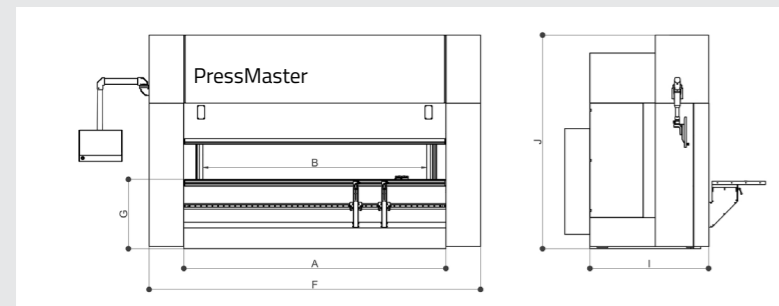

NEW STANDARD

Backgauges

Standard and optional

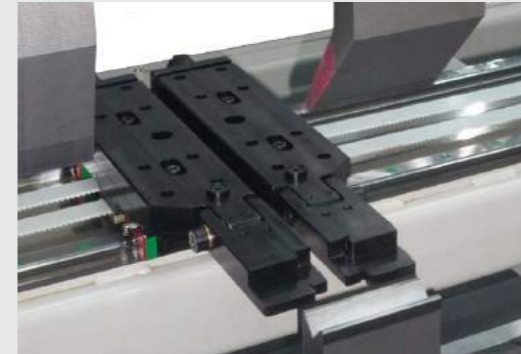

X-R-Z1-Z2 (standard)

Stroke **X** = 800 mm

Max. Speed **X** = 1000 mm/s

Stroke **R** = 130 mm

Max. Speed **R** = 250 mm/s

Max. Speed **Z1-Z2** = 1000 mm/s



X-R-Z1-Z2-X3 (optional)

Stroke **X** = 800 mm

Max. Speed **X** = 1000 mm/s

Stroke **R** = 130 mm

Max. Speed **R** = 250 mm/s

Max. Speed **Z1-Z2** = 1000 mm/s

Stroke **X3** = -50/+50 mm



X1-X2-R1-R2-W1-W2 (optional)

Stroke **X1-X2** = 600 mm

Stroke **R1-R2** = 100 mm (≤ 1500 kN)

= 135 mm (> 1500 kN)

FastBEND-2D/3D MT Premium

Intuitive Bending

The **FastBEND-2D/3D MT Premium** Controls set a new standard in the market for flexible, reliable and high precision sheet metal bending.

Driven by **state-of-the-art PC-based hardware**, the system allows for very fast data processing and highly accurate calculation of the optimal bending programs for hydraulic CNC press brakes.

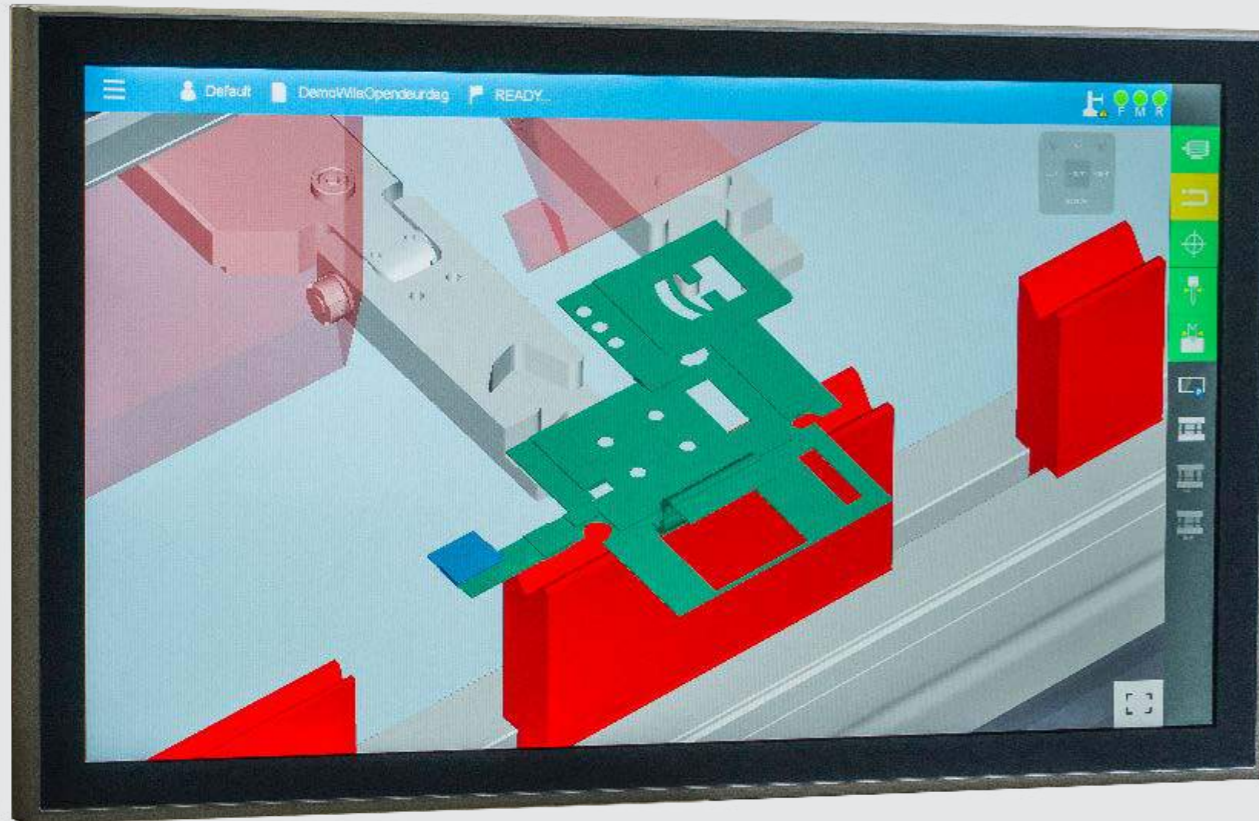

FastBEND-2D/3D MT Premium

Intuitive Bending

Intuitive Interface with a minimum of interactions to draw the workpiece and generate the corresponding program

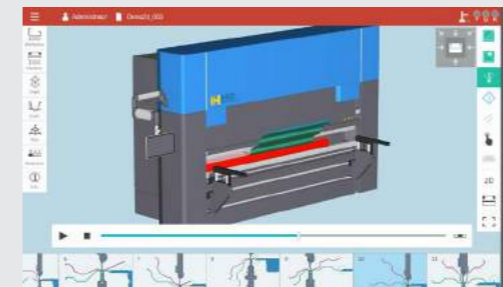

Multi Touch Technology on
24" screen (FastBEND-3D MT Premium)
21,5" screen (FastBEND-2D MT Premium)



Intuitive Interface with combined numerical-graphical user interface

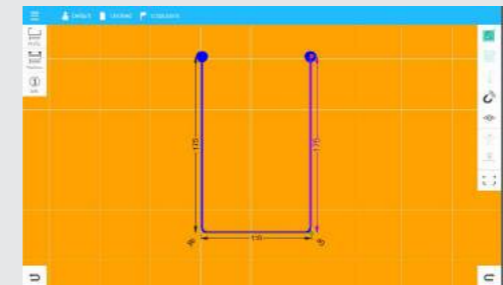

MULTITASKING : Workpiece drawing with instantaneous collision detection and calculation of the bending sequence in the background



SMART DRAFT : Innovative drawing method for generating 2D workpieces



STEP PREVIEWER : bar with possibility of horizontally scrolling of the bending steps



COMBINED ICONS : multiple functionalities by means of one single icon

New Standard Tooling System

Standard for PressMaster, Optional for EuroMaster-S

Wila's **'New Standard' Tooling System** has become market leader for precision, quality and flexibility. The selfseating and selfaligning features considerably improve your set up times and productivity of your pressbrake. Both bottom (OZU) and top (BIU) tooling are clamped hydraulically. The bottom clamping is integrated in the crowning table.

New Standard tooling is safe: the Safety-Click system (for top tools up to 12,5 kg) enables vertical loading and unloading of your top tooling without any risk. For tools with bigger weight, a safety pin or key is applied.

Working surfaces and bending radii of New Standard tooling are hardened and precision ground for maximum longevity.



MAIN BENEFITS

1. Vertical loading and unloading

2. Self-seating and self-aligning

3. High precision and longevity

Optional Smart Tool Locator

Increase your pressbrake productivity

The **Smart Tool Locator (STL)** further increases your pressbrake productivity. The system indicates by means of built-in LED's the right clamping position of your tooling during tool set up and indicates the active tool location in production mode. The Smart Tool Locator offers significant benefits in **speed, precision** and **flexibility**.

Available for all hydraulic New Standard Tool Holders for top and bottom tools.



NEW STANDARD PREMIUM AND PRO TOOLING

Both top (BIU) and bottom (OZU) tools are available in a wide variety of shapes and dimensions. For more detailed information, see the New Standard Tooling Catalogue.

Available for all hydraulic New Standard Tool Holders for top and bottom tools.

Lazersafe Optical Safety Guards

Advanced Safety

CE Safety Regulations require the application of an **Optical Safety Guard (OSG)** when operating at closing speed.

Optical modules (transmitter and receiver) mounted to the ram of the machine monitor the downward movement in the area underneath the top tooling tip. During the fast closing speed, the beam movement is instantaneously stopped when the system detects an obstacle.

EuroMaster-S and PressMaster can be equipped with **LazerSafe LZS-LG-HS** with mute point 6mm (RapidBend) or with **LazerSafe IRIS** (RapidBend Ultimate) with mute point 0 mm.

BOTH SYSTEMS GUARANTEE

a high level of safety for the operator

a high level of machine productivity

security against tooling collision at high speeds

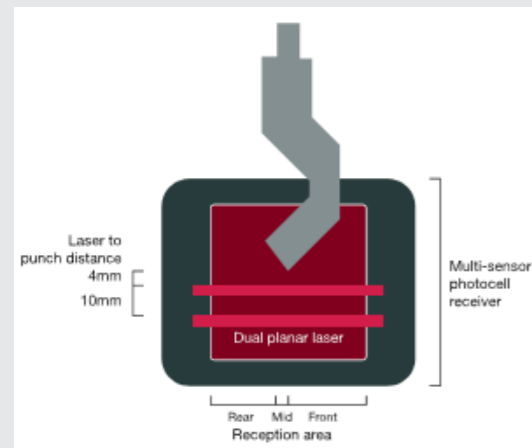

Lazersafe LZS-L6-HS

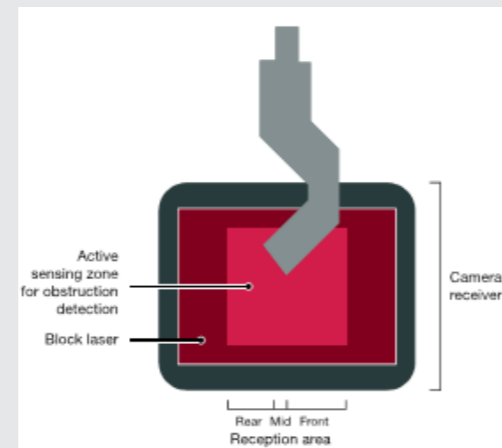

Lazersafe IRIS



Lazersafe Optical Safety Guards IRIS

Features

- Optimal Speed Change Over Point
- Fast Closing Speed in safe conditions (monitoring till mute point 0 mm)
- Faster cycle times
- Ultimate Operator Safety
- Security against tooling damage
- Full Integration in the CNC System
- Automatic Alignment



NORMAL MODE

All sensors + 3 zones active
Fast Approach Speed till mute point
Followed by Working Speed
(unless interruption by obstacle)

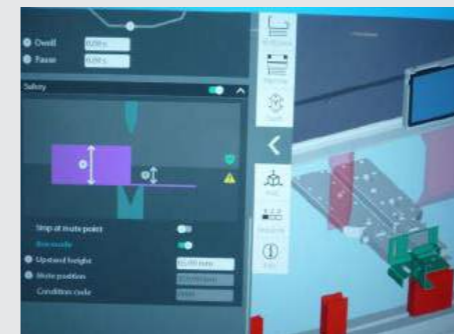

BOX MODE WITH PROGRAMMABLE FLANGE HEIGHT

Programmable flange height
Extra deliberately foot pedal command
Front and Rear zone switched off at flange height



MUTE STOP MODE

Applicable for workpieces with flanges which interrupt the monitored zone in normal mode operation. Initial fast approach till mute point, consequently operator infeed of the workpiece.

Angle Measuring System Alfa-F

Angle Measurement



System consisting of 2 laser beam transmitters and 2 camera's on both sides of the workpiece.

Principle :

Angle Measurement

Force reduction + calculation of the springback

Automatic angle correction (taking into account the calculated springback)



EMS



PM

Angle Measuring System Alfa-F

Features

- **Standard tooling** is applicable – no extra cost for internal measuring units
- No contact elements – **no mechanical wear**
- Contactless angle measurement principle guarantees a **reliable system** even in heavy duty circumstances
- **Different V-openings** and **dies** are applicable, preferable single-V's with minimal height of 100mm
- **Compact assembly** guarantees an optimal working space for operator and material
- **Quick manual adjustment** along the machine length (optional CNC-positioning)
- **Optional parking station** if system is not in operation
- Possibility of **measuring** on workpieces with **apertures**
- **Guaranteed precision**

OPTIONAL

- Extra parking station
- CNC-positioning of the measuring units

Sheet Following Systems

For bending long and thin sheets

Sheet Following Systems are especially recommended when bending **long** and **thin** sheets as they support as well as prevent second bends in your part.

They are very efficient in **supporting heavy parts** during decompression and the beam return movement.

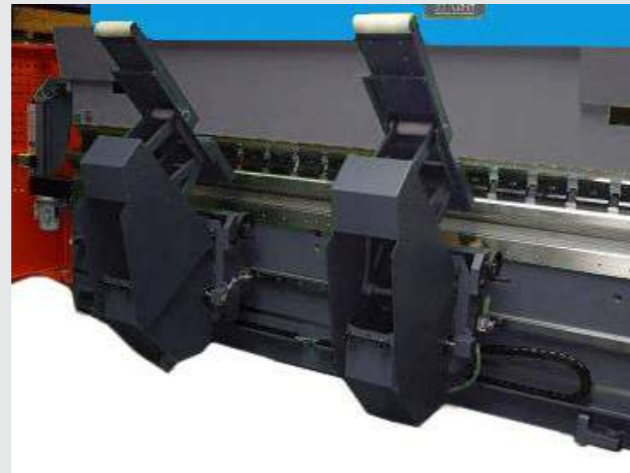

The Sheet Following Units are operating electro-mechanically by means of servo motors, with adjustable speed as a function of the applied V-opening.

They can be adjusted vertically in order to suit different die heights.



EMS



PM

Sheet Following Systems

Optional parking stations

Optional parking stations at right and/or left hand side of your pressbrake allow for parking your sheet following system when not operational. The system is moved out of the bending zone enhancing ergonomics and safety.

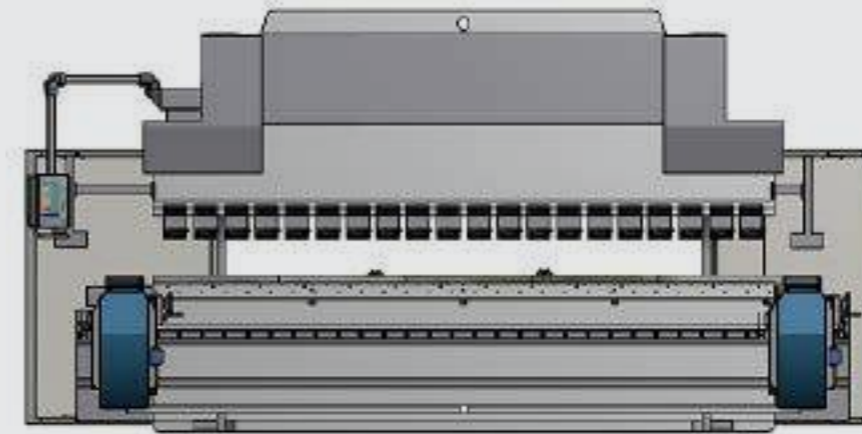

Picture below:

Special Customized Sheet Following System with 1 telescopic arm inclusive width adjustment of the support surface and height adjustment of the following arm.



SyncView

Human and machine become one

SYNCVIEW: BENDING EFFICIENCY

SyncView was invented from the notion that it would be ideal to **watch both screen and workpiece simultaneously** during the bending process. This innovative solution consists of a tablet screen that is automatically positioned at the **optimal location**: where the piece is actually positioned by the operator.

SYNCVIEW SPECIFICATIONS:

- 8" display
- fast, automated positioning to the correct tool location
- Multi-Touch interface
- automated wireless charging



EMS



PM

SyncView

Human and machine become one

SYNCVIEW'S ADVANTAGES

Time-savings & efficiency

The operator no longer has to look at a fixed 3D image on the screen – sometimes meters away from him – time is no longer wasted when bending (complex) parts. With this innovation – in which the 3D image of the bending steps is always right in front of the user – he can understand and carry out the steps quicker during the bending sequence. In addition, the 3D images on the screen can be rotated, without the operator having to leave the work position. This enables an even better and faster evaluation of complex pieces than is possible from a single perspective. User tests indicate time-savings of up to 25% during the actual bending process.

Ergonomics & physical comfort

The operator no longer has to constantly keep turning his head between the screen and the workpiece. Eliminating repetitive torsional movements of the neck and torso reduces long-term health risks. Now, the operator can look in the same direction at both the screen and the workpiece, which simply requires eye movement – producing a more pleasant, natural and comfortable interaction.

Safety & user-friendliness

What's more, should something go wrong, the operator now recognizes it quickly. This is a safety benefit particularly when positioning the piece. The operator is no longer occupied either with the screen or with the workpiece. The workflow becomes one, so to speak – enabling the operator to focus 100% on the bending process itself.

SynchroMaster Series

Your entry-level machine

SynchroMaster Series

SRM

BEAM CONTROL

Beam parallelism and depth stop setting by means of bed referenced linear encoders for accurate beam position measurement, synchro module and proportional valve hydraulics

INTUITIVE EASYBEND-2D CONTROL



DSP OPTICAL SAFETY GUARD (optional)



CROWNING TABLE (OPTIONAL)

Compensates for ram and table deflection, ensuring consistent bending angles over the entire bending length. Manual operation and CNC controlled versions (V-axis)

STANDARD BACKGAUGE X

Rigid backgauge for accurate sheet positioning

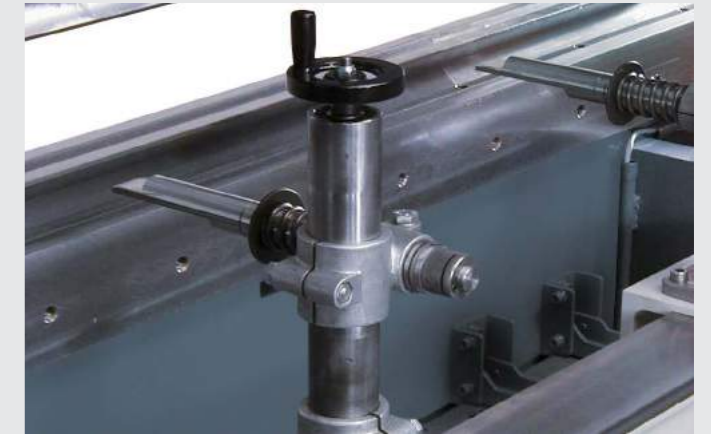

STANDARD EUROPEAN

Quick Manual Upper clamping
Manual bottom clamping



Model 30150
Flush Floor frame
design for all models

SynchroMaster Series

Standard Execution



INTUITIVE EASYBEND-2D GRAPHICAL CONTROL

Intuitive entry level control for 2D applications with graphical support during work piece design and production cycle.

Automatic bending sequence calculation, collision detection and program generation. User friendly interface enabling operation by low to medium skilled operators.



EUROPEAN STANDARD (ES) top tooling with Quick Manual Clamping arrangement

The European Standard Tooling System has proven its flexibility, affordability and precision during the last decades in an infinite number of sheet metal working shops. A wide choice of a vast number of top and bottom tools allows for an unpredictable number of applications in various materials and thicknesses.



X BACKGAUGE, expandable to X-R, X-R-Z/Z' and X-R-Z1-Z2

The SynchroMaster is standard equipped with a rigid and accurate X backgauge featuring average travelling speeds. Optional X-R (height programming), X-R-Z/Z' (symmetric finger programming) and X-R-Z1-Z2 (asymmetric finger programming) are available for increasing your range of applications.

SynchroMaster Series

Standard Execution

- **EasyBEND-2D control**
- **X Backgauge for accurate sheet positioning**
Stroke X = 800mm, maximum speed = 400mm/s
- **European Standard (ES) top clamping with Quick Manual Clamping Arrangement**
- **Intermediate clamping with height 100mm (up to 1500kN) or 150mm (from 2000kN)**

Your Competitive Edge

A. Excellent Value for Money

B. User Friendly EasyBEND-2D graphical control

C. Proven Profitability for Various Workload Conditions

SynchroMaster Series

Technical Specifications

SynchroMaster

EasyBEND-2D Control

	Bending length	Capacity	Distance between housings	Gap	Daylight opening (NS)	Stroke	Table Height	Fast Approach Speed	Max. Bending Speed	Fast Return Speed	Motor Power	Length	Width	Height	Weight
	A		B	C	D	E	F					H	I	J	
MODEL	mm	kN	mm	mm	mm	mm	mm	mm/s	mm/s	mm/s	kW	mm	mm	mm	kg
20075	2100	750	1600	200	280	100	840	80	10	70	7.5	2450	1450	2300	4400
25075	2600	750	2100	200	280	100	840	80	10	70	7.5	2900	1450	2300	4700
30075	3100	750	2600	200	280	100	840	80	10	70	7.5	3500	1450	2300	5100
25100	2600	1000	2100	250	400	200	875	100	10	80	11	2900	1700	2500	6900
30100	3100	1000	2600	250	400	200	875	100	10	80	11	3500	1700	2500	7400
36100	3600	1000	3150	250	400	200	875	100	10	80	11	4100	1700	2500	8200
40100	4100	1000	3150	250	400	200	915	100	10	80	11	4400	1700	2500	9100
43100	4300	1000	3750	250	400	200	915	100	10	80	11	4700	1700	2850	10600
25150	2600	1500	2100	250	400	200	915	100	10	80	15	2900	1700	2500	7700
30150	3100	1500	2600	250	400	200	915	100	10	80	15	3500	1700	2500	8200
36150	3600	1500	3150	250	400	200	915	100	10	80	15	4100	1700	2500	9300
40150	4100	1500	3150	250	400	200	915	100	10	80	15	4400	1700	2500	10400
43150	4300	1500	3750	250	400	200	1010	100	10	80	15	4700	1700	2850	12900
25200	2600	2000	2100	300	450	200	965	100	8	100	15	2820	2000	2750	11200
30200	3100	2000	2600	300	450	200	965	100	8	100	18.7	3320	2000	2750	11600
36200	3600	2000	3150	300	450	200	965	100	8	100	18.8	3880	2000	2800	14500
40200	4100	2000	3150	300	450	200	965	100	8	100	18.7	4320	2000	2800	15400
43200	4300	2000	3750	300	450	200	965	100	8	100	18.7	4520	2000	2900	17200
30250	3100	2500	2600	300	450	200	965	100	8	90	18.7	3320	2050	2800	12900
36250	3600	2500	3150	300	450	200	965	100	8	90	18.7	3380	2050	2800	16000
40250	4100	2500	3150	300	450	200	890	100	8	90	18.7	4320	2050	2800	16900
43250	4300	2500	3750	300	450	200	890	100	8	90	18.7	4520	2050	3000	18700
50250	5000	2500	4050	300	450	200	940	100	8	90	18.7	5700	2050	3250	24300
60250	6000	2500	5050	300	450	200	1090	80	8	45	18.7	6700	2050	3700	31000
30320	3100	3200	2600	330	500	250	890	80	8	100	18.7	3320	2050	3000	17500
36320	3600	3200	3150	330	500	250	890	80	8	100	22.5	3880	2050	3100	20000
40320	4100	3200	3150	330	500	250	890	80	8	100	22.5	4320	2050	3200	21500
43320	4300	3200	3750	330	500	250	890	80	8	100	22.5	4520	2050	3200	23500
50320	5000	3200	4050	330	500	250	940	80	8	100	22.5	5500	1980	3300	28000
60320	6000	3200	5050	330	500	250	1090	80	8	100	22.5	6500	1980	3700	33000

Specifications subject to modifications without price notice

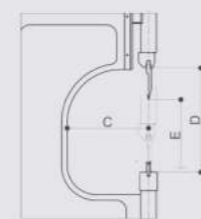
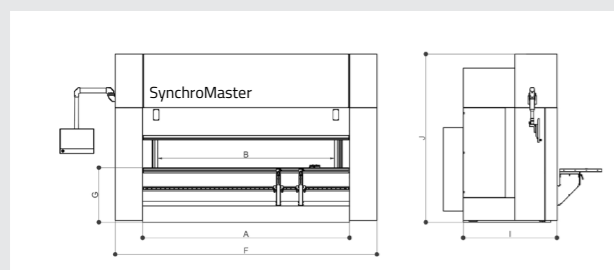

NEW STANDARD

EASYBEND-2D CONTROL

- Multiple drawing methods
- Graphic simulation of work pieces with
- **Multitasking Real Time solution Finding**
- **Automatic bending sequence calculation** with collision control
- Automatic program generation
- **10.4"** colour graphic LCD display
- Expandable up to **7 axes**:
 - standard Y1 + Y2
 - Standard X-axis
 - optional R-axis
 - optional X-R-Z/Z' and X-R-Z1-Z2 axes
 - optional crowning (= V-axis)
- Material library up to **30 different materials**
- Tool library with graphical visualisation for
- **30 upper and 30 lower tools**
- **USB Support** (stick included) + Network board
- **Programmable Beam Speed and Speed Change-Over Point**
- **Top Death Centre (TDC)**, Back gauge Positioning with retraction



SynchroMaster

Optional equipment

X-R BACKGAUGE



MANUAL CROWNING

Manual Anti-Deflection table for European Standard Bottom tooling

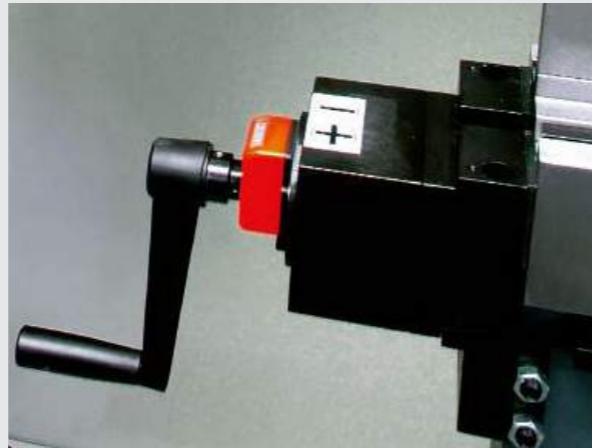

CNC CROWNING

Motorised CNC controlled anti-deflection table for European Standard and single V-dies

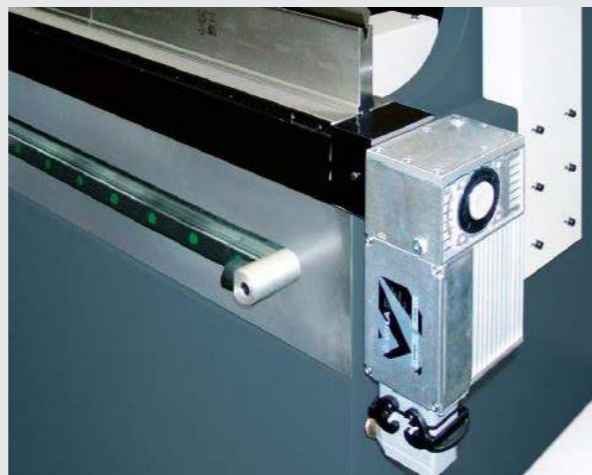

SynchroMaster

Optional equipment

TYPE I FRONT STOP



DSP OPTICAL SAFETY GUARD

The CE regulation allows only Fast Approach Speed when applying an optical safety guard moving with the closing beam.

This guard is mounted to the beam and can be adjusted manually in height.

When detecting an obstacle within the protected area around the tip of the upper tooling, the system interrupts the downward movement instantaneously.



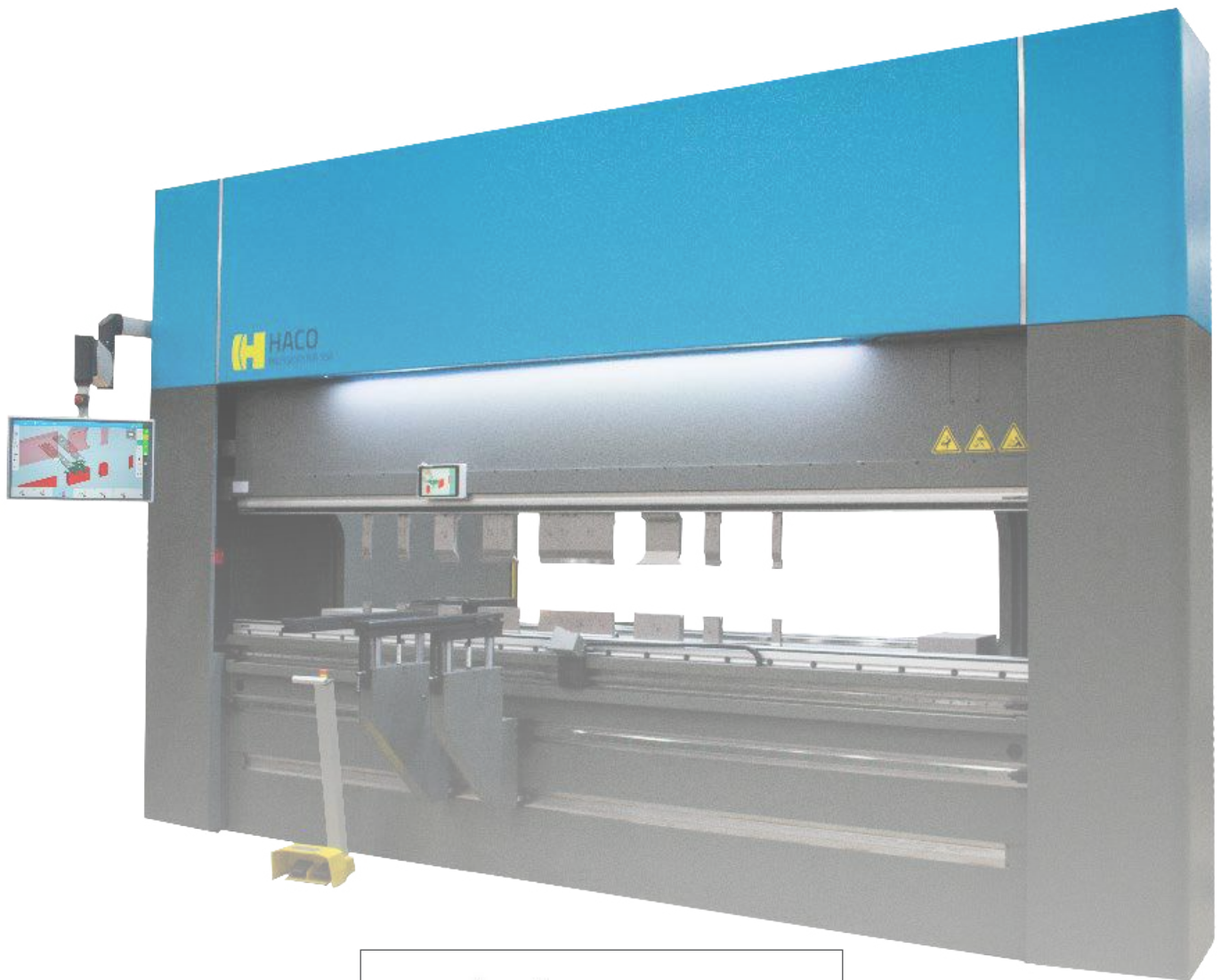

Fiber Laser Cutting



Robot Bending



Punching

HACO NV
 Oekensestraat 120
 8800 Roeselare
 Belgium
 T +32 (0) 51 26 52 00
 E-Mail: info@haco.com
 www.haco.com

**PRESSMASTER
 EUROMASTER S
 SYNCHROMASTER**